

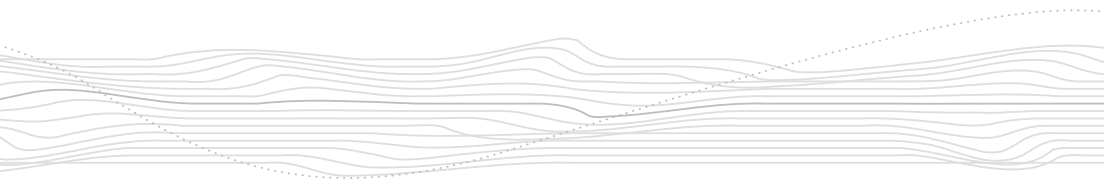

12 Pole PAS Sensor for Ebikes with CA3

- Add Automatic Pedal Assist to your Ebike
- 12 Pole Magnet Ring for Quick Response
- Includes 3 Styles of Magnet Ring for Any Installation
- Quadrature (2 wire) Output Signals for Left or Right Side Install

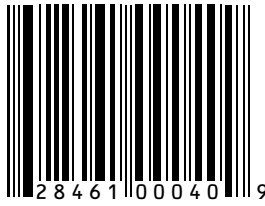



Part #: **PAS_12P**

Install Magnet Ring to Crankset.

Mount on chainring

Fits most 74mm (5 bolt) and 64mm (4 bolt) cranksets.
Requires steel chainring bolts.

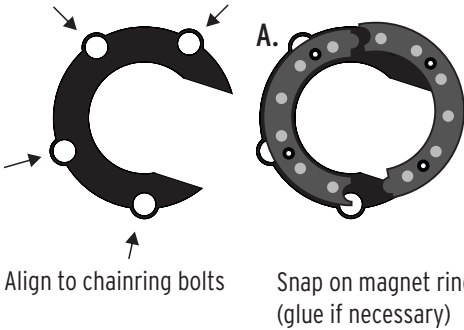

Mount on spindle

B. (easiest)

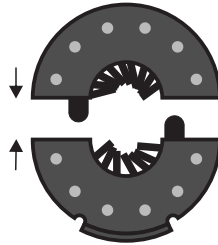

Fit the split ring around the spindle and then snap on the retaining ring.

C. (most secure)

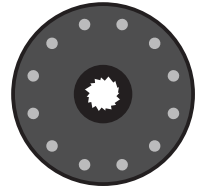

Remove crankset and slide the whole magnet ring in place.

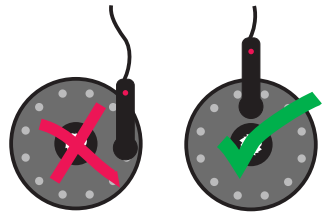
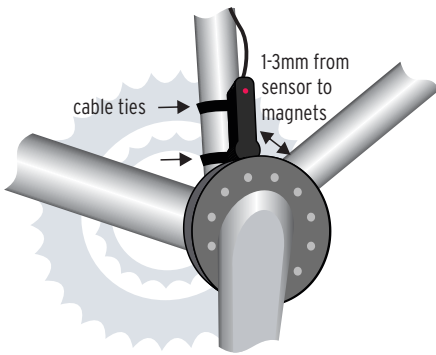

Must be aligned radial, not tangential

Specifications

Cable Length

90 cm

Connector

5-Pin Male JST SM
1=V+(5-10V), 2=Gnd, 3=S1, 4=S2, 5=NC



For more information, visit www.ebikes.ca



Advancing the world of
ebike parts and accessories

www.ebikes.ca